



INSTALLATION GUIDE & USER MANUAL AFLD30BK/CCT



ENSURE POWER SUPPLY IS OFF WHEN HANDLING ANY ELECTRICAL EQUIPMENT.

- This product may need to be installed by a qualified electrical installer.
- Please read this guide in its entirety to fully understand the products before attempting any install.
- All electrical work should be completed in accordance with the latest IET regulations, and/or any other relevant rules, regulations or laws of the country in which it is being installed.
- The item must be installed in isolation from any insulating material and be adequately ventilated to prevent premature failure.
- Ensure power supply is isolated prior to installation, maintenance or performing any other form of electrical work.
- In the event of incorrect or improper function with specific regard to any of ALL LED's products and contact ALL LED for further advice.



Installation Instructions

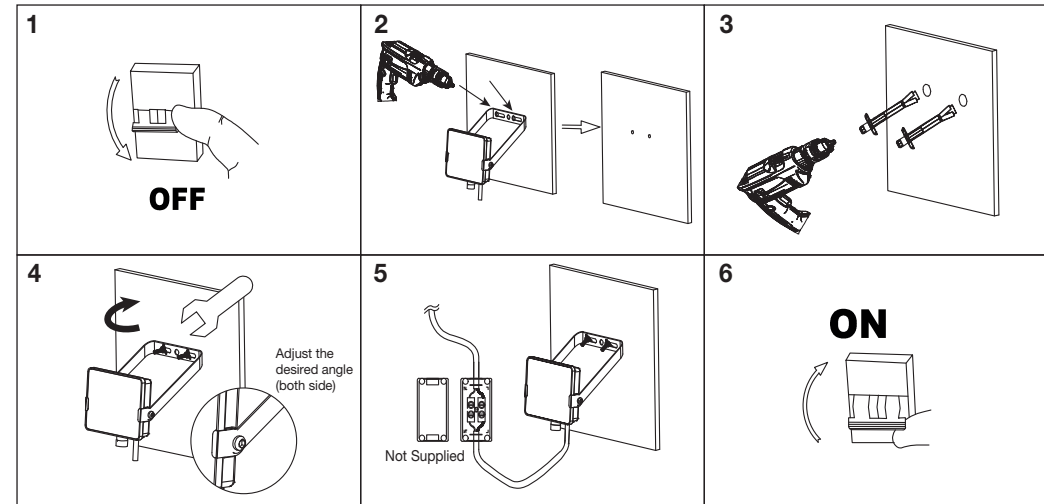

Technical Specifications

Product Code	AFLD30BK/CCT		
Luminous Flux (LM)	2670lm	3070lm	2660lm
Useful Luminous Flux (LM)	2330lm	2680lm	2320lm
CCT (Kelvin)	3000K	4000K	6000K
Beam Angle (°)	110°		
SDCM	<6		
CRI	>80		
Peak Intensity (cd)	1005cd	1149cd	986cd
Operating Voltage (V)	220-240V AC		
Max Output Power (W)	30W		
Operating Current (A Max)	0.17A		
Standby Power (W)	<0.5W		
Power Factor (Pf)	0.76		
Class	I		
Body Material	Aluminium		
Frame Colour	Carbon Black		
Switching Cycles	30,000		
Ingress Protection	IP65		
Ambient Operating Temperature (°C)	-20°C ~ +45°C		
Input Frequency (Hz)	50-60Hz		
Guarantee	3 Years		
Cable Length	1m		
Lifetime (L70 B50)	30,000 Hrs		
Survival Factor	0.9		
Lumen Maintenance Factor	0.1		
Flicker Metric (PstLM)	<1		

- Hold the product in position and mark the location of the fixing holes. The bracket can be removed from the fitting for ease of installation.
- Fix the bracket to the wall using expansion bolts (not supplied). Take care to avoid damaging any concealed wiring and pipes. The correct fixings should be used for brick or cavity walls.
- Using an Allen key (not supplied), loosen the bolts on the side, and adjust the fitting to the desired angle.
- Wire as required.
- Ensure that the cable is not snagged. Re-tighten the bolts.
- Turn on power switch. Light is ready for use.

Dimensions (mm)

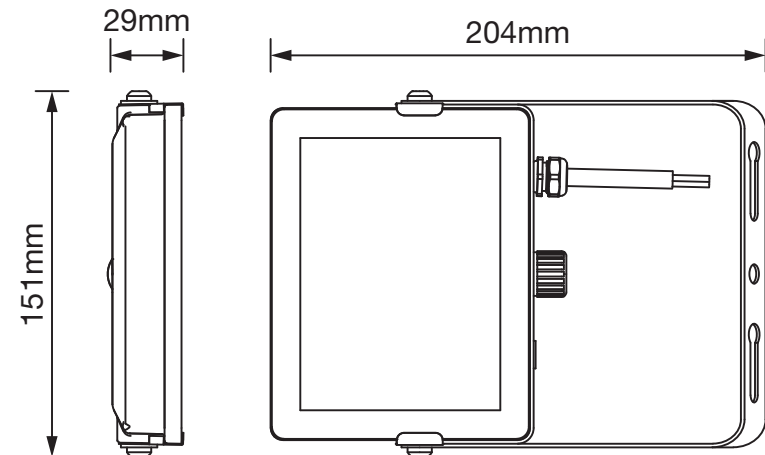

Troubleshooting Guide

PROBLEM	CAUSE(S)	SOLUTION(S)
No Light Output From LEDs	No power to drive components	A qualified installer/electrician should check the primary voltage side of the product to check the input voltage
	Loose connection on circuit	Ensure continuous and correct connection between terminals
	Overvoltage may have caused damage to the sensitive components	These cases are rare and the item may need replacement and/or investigation as to the cause of failure
LEDs Flashing	Incorrect voltage range being used	Please ensure there is a regulated AC voltage supply within the parameters of the luminaire. Failure to do so will void the warranty
	LED driver may be connected to a mains dimmer switch	Please remove the dimmer switch and wire the unit to a switch, removing any mains dimmers or other dimmers on the primary side. Use of this product on a dimmer will void the warranty
	Loose connection on circuit	Ensure continuous and correct connection between the terminals

Safety

- Do not cover the ground contact.
- Do not cover the luminaire, hang or fasten anything from it.
- Do not operate if any visible damage can be seen to the product.
- Do not operate if any water ingress has occurred.
- Do not operate if any smoke, steam or crackling noises can be heard from the luminaire.
- Do not operate if any signs of overheating are recognised.
- Avoid installation in any areas where there is a risk of strong mechanical loads.
- Do not place any material over the lens or LED diode/chip.
- Do not insert objects into the luminaire.
- Do not clean using any solvent based abrasive or aggressive product.
- Do not pull any cables connected to the product.
- Do not direct the luminaire into a person's eyes, as this unit may have an intense light output, which if incorrectly used may cause eye damage.
- Light engines/LEDs and other light sources may heat up, please take care when handling the products.
- The manufacturer will not be deemed liable or held responsible for any damages caused by faults or manufacturing defects that may be present in any of its products or the misuse or incorrect installation of this device. Please refer to our troubleshooting guide for further information.
- The manufacturer will not be held liable for any death(s) or injuries caused by misuse or poor installation or any unreported faults of this product version or versions thereof.
- LEDs are sensitive to electrostatic discharge. Do not touch the surface of the LED module.
- Do not connect to a temporary electricity supply, this may damage the electronics.
- Light fittings with an integrated emergency option come with a separate installation and wiring leaflet. Please refer to this manual for further details. If the manual is unavailable please contact an ALL LED representative for assistance.
- It is strongly recommended that a Residual-Current Device (RCD) is used with this product to minimise the risk of electrocution.
- REPLACE DAMAGED GLASS IMMEDIATELY.
- Keep away from children.
- Do not install in areas with; high acid rain, acidic soil, high salt content, coastal environments, high concentration of chemical substances.

Returns & Faulty Items

- If any problem is encountered during or after installation, please call ALL LED technical department to get the problem resolved as soon as possible.
- Please do not just return the item to the outlet you purchased it from, as you are only entitled to a replacement or refund after the unit has undergone testing and the unit has been confirmed as having a manufacturing defect/fault. Your statutory rights are not affected.
- The manufacturer will not be deemed liable or held responsible for any damages caused by faults or manufacturing defects that may be present in any of its products or the misuse or incorrect installation of this device.
- All installations must be carried out in accordance with this installation guide and user manual.
- All goods are supplied under the terms and conditions of ALL LED LTD, a copy of which may be obtained upon written request.



ATTENTION

IF ANY PROBLEMS PERSIST, PLEASE CALL THE ALL LED TECHNICAL DEPARTMENT FOR FURTHER ASSISTANCE.



ALL LED LTD
42 Sedgwick Road,
Luton, LU4 9DT

www.allledgroup.com
sales@allledgroup.com
Tel: +44 (0)208 841 9000



Environmental Protection
Waste electrical products should not be disposed of with household waste. Please recycle where facilities exist. Check with your Local Authority or retailer for recycling advice



ISOLATE MAINS SUPPLY BEFORE HANDLING ANY ELECTRICAL PRODUCTS

The manufacturer will not be deemed liable or held responsible for any damages caused by faults or manufacturing defects that may be present in any of its products or the misuse or incorrect installation of this device
Your statutory rights are not affected.

